

profiPANEL

type PPD 180 (90/90)

article-no.: 332.180.AAA

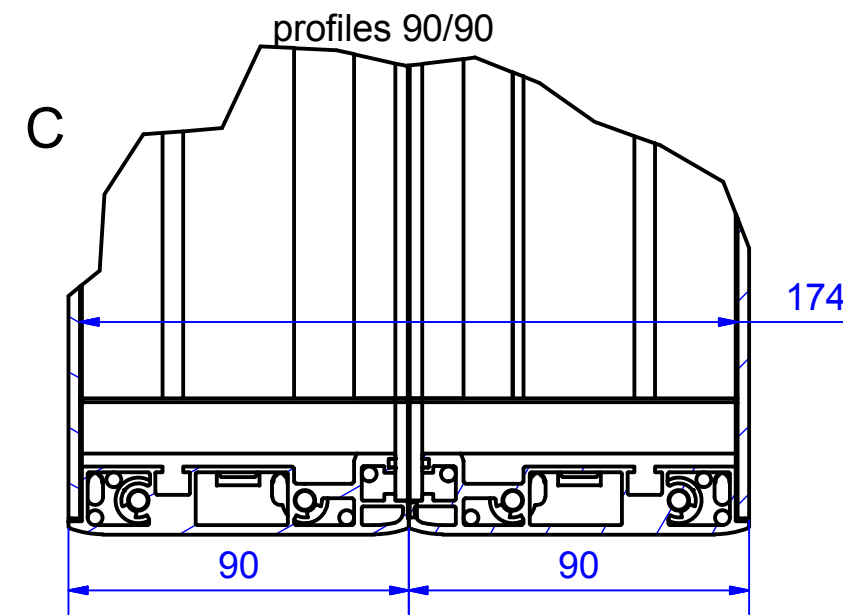
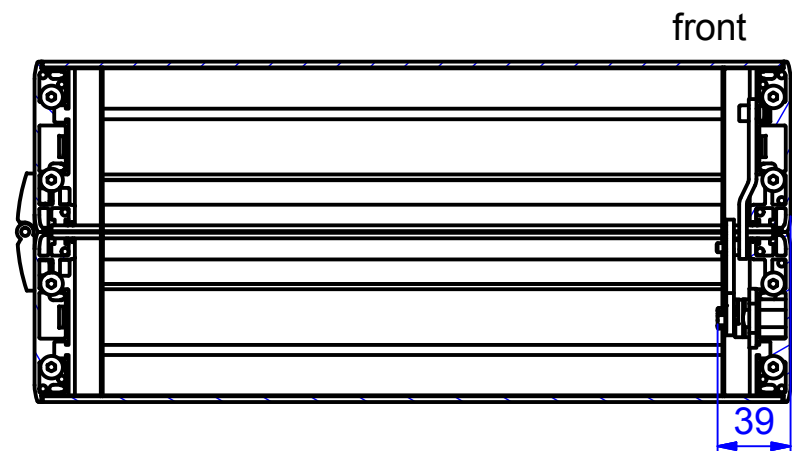
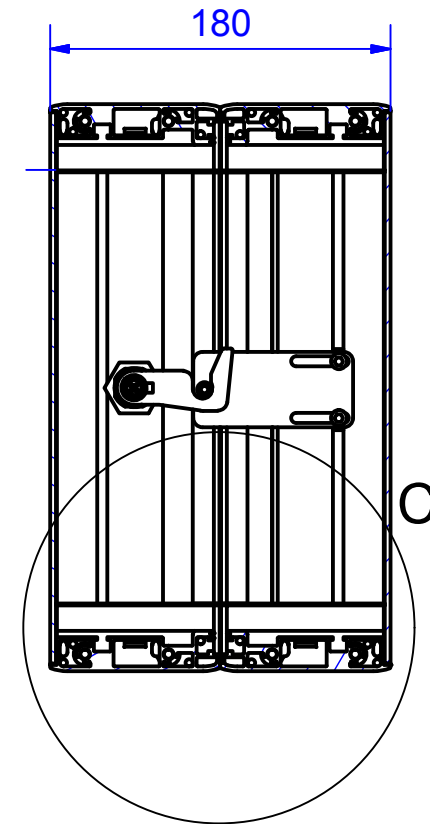
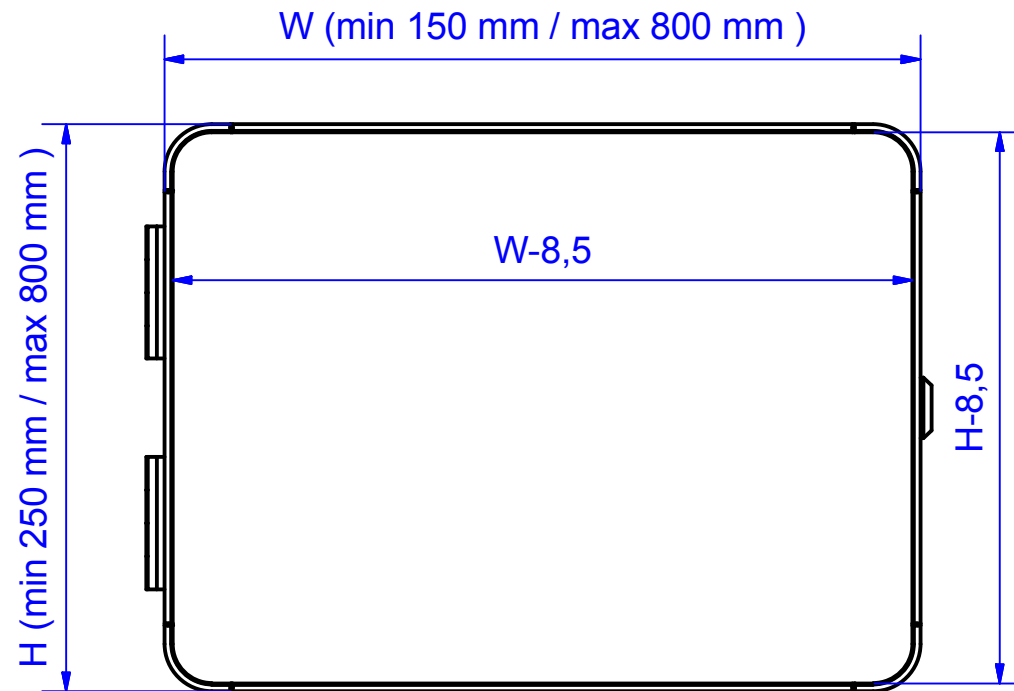

useable front-plate area= nominal size -50 mm
area reduction generated by lock and hinge combination

*1 lock on side for dimension H < 600 mm
2 locks on side for dimension H ≥ 600mm
(distance between locks= H-300mm)

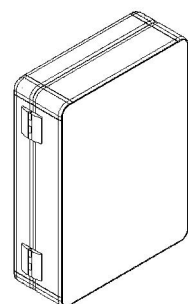

enclosure material	aluminium profile (AlMgSi0,5) anodized , corner (AlSi 12)		front panel	aluminium 3mm, anodized
door	hinges and locks		corner covers	PA RAL 7035
protection class	IP65 EN 60529		tolerances	outside dimension+/-1mm; others DIN 2768-m
weight	depends on configuration			